

A5712/...

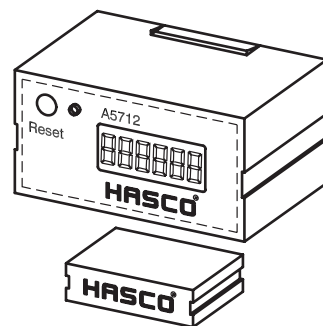

► Info

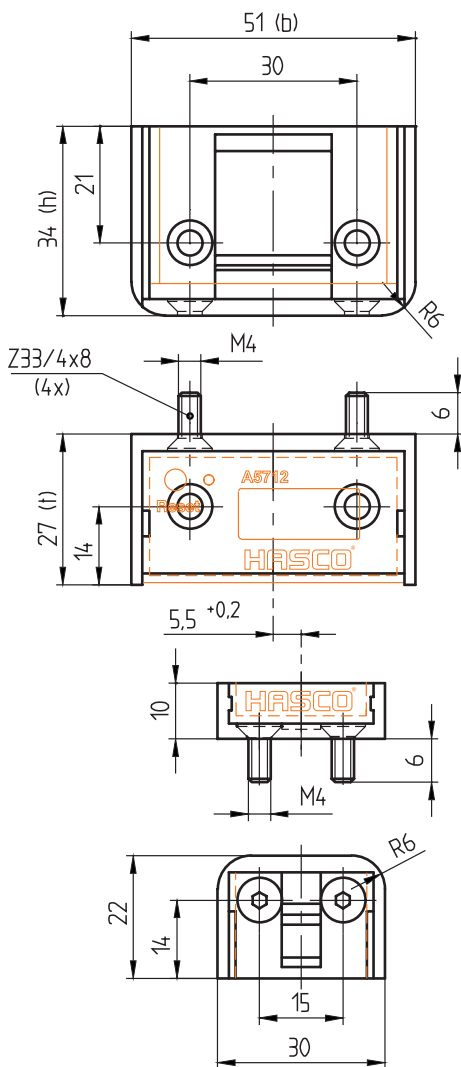

b	h	t	Nr./No.
51	34	27	A5712/51x34x27

This is trial version
www.adultpdf.com